

KA05

ILLUSTRATED ASSEMBLY MANUAL HKA05P'1

IN/OUT shield for Arduino®



velleman®
projects

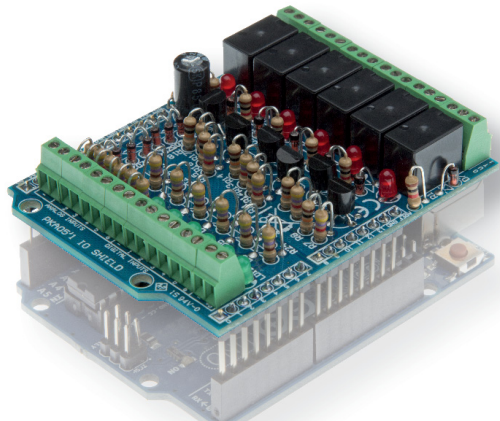

General purpose INPUT - OUTPUT shield for Arduino®

Features

- For use with Arduino Due™, Arduino Uno™, Arduino Mega™
- 6 analog inputs
- 6 digital input
- 6 relay contact outputs
- Indicator leds for relay outputs and digital inputs

Specifications

- Analog inputs: 0..+5VDC
- Digital inputs: dry contact or open collector
- Relays: 12V
- Relay contacts: NO/NC 24VDC/1A max.
- Dimensions: 68 x 53mm / 2.67 x 2.08"



Search product

Search Product

Navigation

- ▶ Main page
- ▶ Products
- ▶ Sales outlets
- ▶ Support
- ▶ Publications
- ▶ Jobs
- ▶ About us

News

NEW MK193 LED CUBE
CubeAnimator software
available for download
here!!
Posted on 04-06-12
[Read more...](#)

Velleman Projects Newsletter

Are you an electronics enthusiastic or simply interested in our kits, minikits, modules and instruments?
Subscribe to our Newsletter and receive every month the latest news, new products & updates on Velleman Projects.

You will receive an e-mail. Click on the link in that e-mail to confirm your subscription.

Email:



Do you want to unsubscribe? Click on the 'unsubscribe' link in the footer of the last received newsletter from Velleman Projects.

- velleman.eu
 - hpower.eu
 - perl.eu
 - vellemanproject.com
All - modules - instruments
 - velbus.eu
 - forum.velleman.eu
- Advertisements
- DAC1
 - DAC2
 - A1
 - K855(N) / VM110(N)
Android Application



Subscribing our newsletter?, visit www.vellemanprojects.eu

login register

View unanswered posts | View active topics

It is currently Fri Sep 14, 2012 9:59 am

Board index All times are UTC

Forum	Topics	Posts	Last post
General			
Forum index / Règlements du forum Read First / A lire en premier lieu Moderator: velleman Support	3	2	Wed Dec 05, 2008 05:44 am Velleman
Forum Administratif Velleman - Inhouse Forum Discussions Moderator: velleman Support	1	4	Thu May 03, 2012 11:22 pm VLA41
Velbus			
Velbus Home Automation Special section for our new Velbus Home Automation System (Domoticz) Moderator: velleman Support	404	3073	Tue Sep 11, 2012 11:11 pm Dario
Kits (Soldiering projects - Projects à souder)			
General For other topics, general tips and tricks, new ideas Moderator: velleman Support	135	428	Wed Sep 05, 2012 3:37 pm VLA41
Audio Hi-Fi Projects All audio related projects, amplifiers, valve amplifiers Moderator: velleman Support	207	2400	Fri Sep 14, 2012 10:32 am VLA41
PC Related Projects For projects that are connected to the PC via interface cards Moderator: velleman Support	1438	6940	Thu Sep 19, 2012 8:04 pm Paris
Microcontroller Programmer - Experimenting Projects Here you can discuss PIC programming, avr, arduino, etc. Moderator: velleman Support	457	1749	Tue Sep 11, 2012 4:27 am Dario
Remote and Clocks All about our time related projects from regular clocks to programmable times Moderator: velleman Support	161	884	Fri Sep 07, 2012 6:40 am VLA41
Home Projects Household related projects, from light drivers to remote control Moderator: velleman Support	626	2283	Fri Sep 14, 2012 12:00 pm VLA41



Participate our Velleman Projects Forum



Velleman N.V.

Legen Heirweg 33

9890 Gavere

(België)

assembly hints

1. Assembly (Skipping this can lead to troubles !)

Ok, so we have your attention. These hints will help you to make this project successful. Read them carefully.

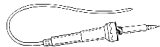

1.1 Make sure you have the right tools:

- A good quality soldering iron (25-40W) with a small tip.
- Wipe it often on a wet sponge or cloth, to keep it clean; then apply solder to the tip, to give it a wet look. This is called 'thinning' and will protect the tip, and enables you to make good connections. When solder rolls off the tip, it needs cleaning.
- Thin rosin-core solder. Do not use any flux or grease.
- A diagonal cutter to trim excess wires. To avoid injury when cutting excess leads, hold the lead so they cannot fly towards the eyes.
- Needle nose pliers, for bending leads, or to hold components in place.
- Small blade and Phillips screwdrivers. A basic range is fine.

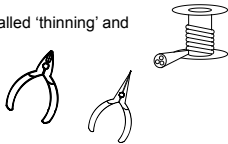

ⓘ For some projects, a basic multi-meter is required, or might be handy



1.2 Assembly Hints :

- Make sure the skill level matches your experience, to avoid disappointments.
- Follow the instructions carefully. Read and understand the entire step before you perform each operation.
- Perform the assembly in the correct order as stated in this manual
- Position all parts on the PCB (Printed Circuit Board) as shown on the drawings.
- Values on the circuit diagram are subject to changes, the values in this assembly guide are correct*
- Use the check-boxes to mark your progress.
- Please read the included information on safety and customer service

* Typographical inaccuracies excluded. Always look for possible last minute manual updates, indicated as 'NOTE' on a separate leaflet.

1.3 Soldering Hints :

1. Mount the component against the PCB surface and carefully solder the leads



2. Make sure the solder joints are cone-shaped and shiny

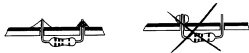

3. Trim excess leads as close as possible to the solder joint



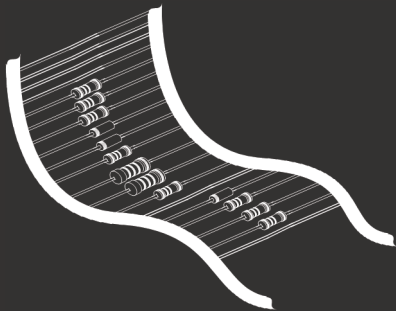

REMOVE THEM FROM THE TAPE ONE AT A TIME !

Included in
this kit

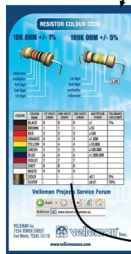

2. RESISTOR

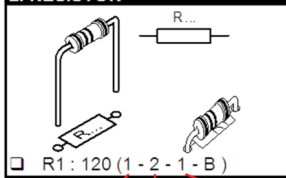

COLOUR	COLOUR NAME	1ST DIGIT/ STRIPE	2ND DIGIT/ STRIPE	3RD DIGIT/ STRIPE	MULTIPLIER STRIPE	TOL- 4TH!
Black	BLACK	0	0	0	x1	1%
Brown	BROWN	1	1	1	x10	
Red	RED	2	2	2	x100	
Orange	ORANGE	3	3	3	x1.000	
Yellow	YELLOW	4	4	4	x10.000	
Green	GREEN	5	5	5	x100.000	
Blue	BLUE	6	6	6	x1.000.000	

DO NOT BLINDLY FOLLOW THE ORDER OF THE COMPONENTS ONTO THE TAPE. ALWAYS CHECK THEIR VALUE ON THE PARTS LIST!

I CONSTRUCTION

1 Ceramic capacitor

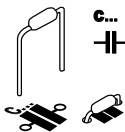

- C2: 100nF (104)

2 Diodes

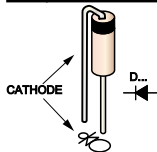

Watch the polarity!

- D1 : 1N4148
- D2 : 1N4148
- D3 : 1N4148
- D4 : 1N4148
- D5 : 1N4148
- D6 : 1N4148
- D7 : 1N4148
- D8 : 1N4148
- D9 : 1N4148
- D10: 1N4148
- D11: 1N4148
- D12: 1N4148

3 Zenerdiodes

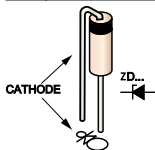

- ZD1 : 5V1
- ZD2 : 5V1
- ZD3 : 5V1
- ZD4 : 5V1
- ZD5 : 5V1
- ZD6 : 5V1

Watch the polarity!

4 LED

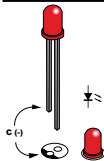

- LD1 : Red
- LD2 : Red
- LD3 : Red
- LD4 : Red
- LD5 : Red
- LD6 : Red

Watch the polarity!

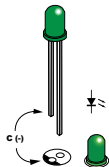

- LD7 : Green
- LD8 : Green
- LD9 : Green
- LD10: Green
- LD11: Green
- LD12: Green

5 Transistors



- T1: BC547B
- T2: BC547B
- T3: BC547B
- T4: BC547B
- T5: BC547B
- T6: BC547B

6 Resistors

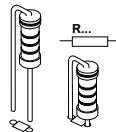

- R1 : 1K (1-0-2-B)
- R2 : 1K (1-0-2-B)
- R3 : 1K (1-0-2-B)
- R4 : 1K (1-0-2-B)
- R5 : 1K (1-0-2-B)
- R6 : 1K (1-0-2-B)
- R7 : 4K7 (4-7-2-B)
- R8 : 10K (1-0-3-B)
- R9 : 4K7 (4-7-2-B)
- R10: 10K (1-0-3-B)
- R11: 4K7 (4-7-2-B)
- R12: 10K (1-0-3-B)

- R13: 4K7 (4 - 7 - 2 - B)
- R14: 10K (1 - 0 - 3 - B)
- R15: 4K7 (4 - 7 - 2 - B)
- R16: 10K (1 - 0 - 3 - B)
- R17: 4K7 (4 - 7 - 2 - B)
- R18: 10K (1 - 0 - 3 - B)
- R19: 470 (4 - 7 - 1 - B)
- R20: 470 (4 - 7 - 1 - B)
- R21: 470 (4 - 7 - 1 - B)
- R22: 470 (4 - 7 - 1 - B)
- R23: 470 (4 - 7 - 1 - B)
- R24: 470 (4 - 7 - 1 - B)
- R25: 4K7 (4 - 7 - 2 - B)
- R26: 4K7 (4 - 7 - 2 - B)
- R27: 4K7 (4 - 7 - 2 - B)
- R28: 4K7 (4 - 7 - 2 - B)
- R29: 4K7 (4 - 7 - 2 - B)
- R30: 4K7 (4 - 7 - 2 - B)

7 Terminal blocks

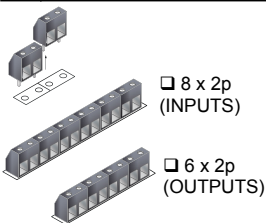

8 Relays

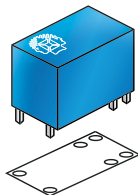

- RY1
- RY2
- RY3
- RY4
- RY5
- RY6

9 Electrolytic capacitors



Watch the polarity!

- C1 : 100µF

10 Male header

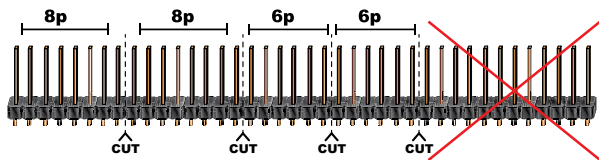

2 X 6 pins

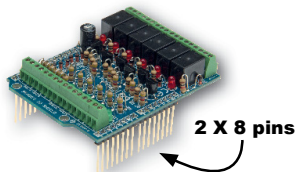

II CONNECTION DIAGRAM

1 OUTPUT MAX. 24VDC / 1A

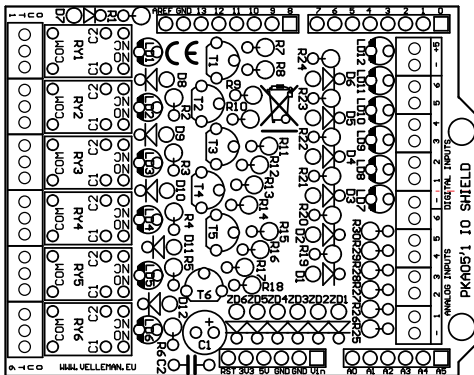
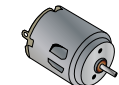

2 DIGITAL INPUTS



101011101011001...

...

3 ANALOG INPUTS 0 ... 5V



DOWNLOAD SAMPLE CODE FROM KA05 PAGE ON WWW.VELLEMAN.BE

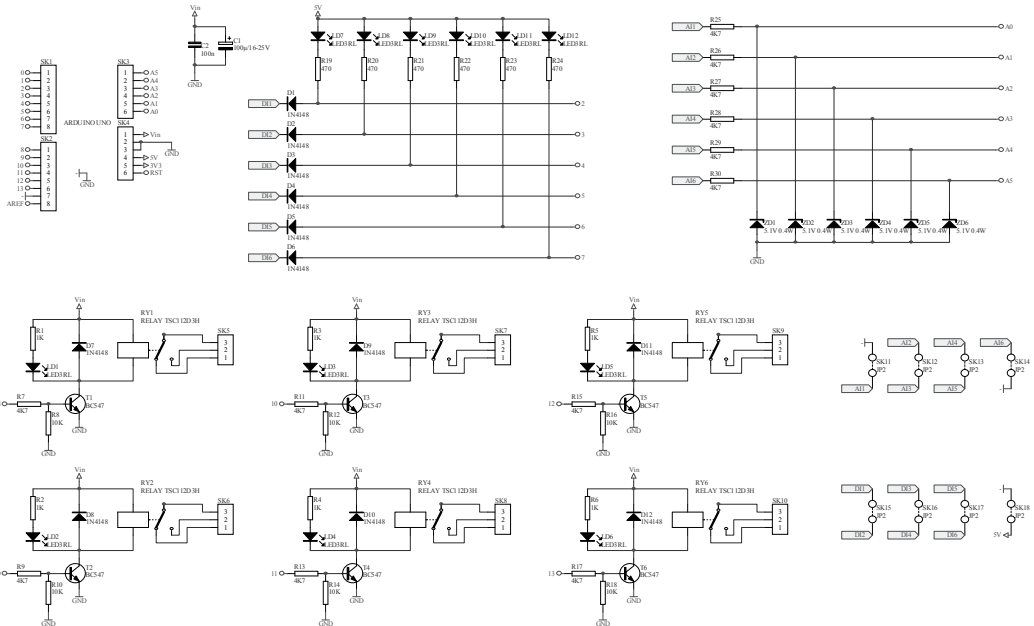

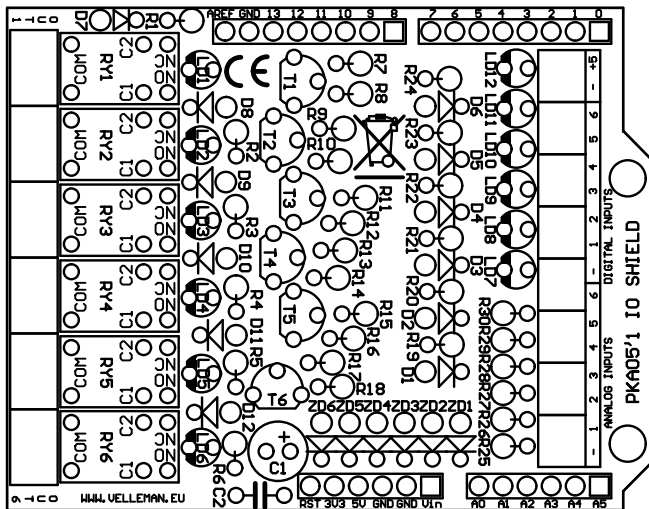

Leds and how to use them

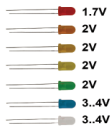

Leds feature a specific voltage drop, depending on type and colour. Check the datasheet for exact voltage drop and rated current !

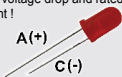

Never connect leds in parallel

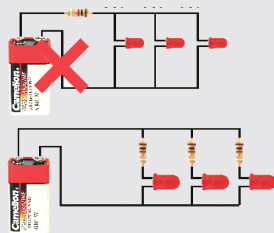

How to Calculate the series resistor:

Example: operate a red led (1.7V) on a 9Vdc source.

Required led current for full brightness: 5mA (this can be found in the datasheet of the led)

$$\frac{\text{Supply voltage (V) - led voltage (V)}}{\text{required current (A)}} = \text{series resistance (ohms)}$$



$$\frac{9V - 1.7V}{0.005A} = 1460 \text{ ohm}$$

closest value :
use a 1k5 resistor

Required resistor power handling=
voltage over resistor x current passed trough resistor



$$(9V - 1.7V) \times 0.005A = 0.036W$$

a standard 1/4W resistor
will do the job

LEDs in series:

Example: 3 x red led (1.7V) on 9V battery
Required led current for full brightness: 5mA
(this can be found in the datasheet of the led)

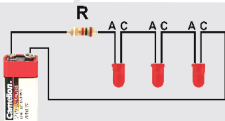

$$\frac{\text{Supply voltage (V) - (number of leds x led voltage (V))}}{\text{required current (A)}} = \text{series resistance (ohms)}$$



$$\frac{9V - (3 \times 1.7V)}{0.005A} = 780 \text{ ohm}$$

use an
820 ohm resistor

open collector outputs

An open collector output can be compared to a switch which switches to ground when operated

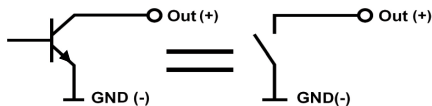

Example: How to switch an LED by means of an open collector output

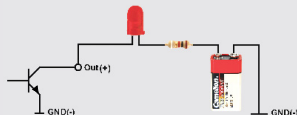

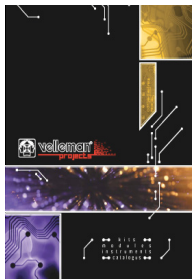

The new Velleman Projects catalogue is
now available. Download your copy here:
www.vellemanprojects.eu



Modifications and typographical errors reserved - © Velleman nv. HKA05'IP
Velleman NV, Legen Heirweg 33 - 9890 Gavere.