

# K8094

ILLUSTRATED ASSEMBLY MANUAL H8094IP'1

## EXTENDED RECORD PLAYBACK KIT



velleman®  
projects

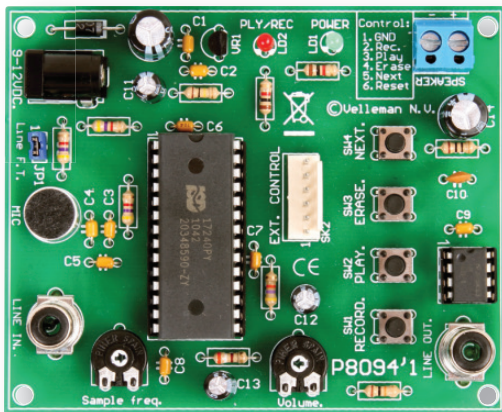

Allows you to record and play messages  
of up to 8 minutes long.

The K8094 allows you to record and play messages of up to 8 minutes long.

Recording speed is continuously adjustable so that you can choose a perfect compromise between duration and sound quality. It also allows you to generate funny sound effects. Messages are retained in memory at power loss. The unit comes complete with microphone, line level in- and output and an output for a small speaker. Applications: Play messages in musea, stores, interactive installations, scale models, toys, as doorbell, gadget, etc...

---

### **Features**

- record duration:
  - standard quality: 8 minutes
  - high quality: 2 minutes 40s.
- built-in microphone
- line level in- and output
- pushbutton control (suited for open collector control)

### **Specifications**

- power supply: 9...12VDC
- consumption:
  - idle: <15mA
  - playback: 100mA max.
- speaker output: 500mW (8 ohm - 10% THD)
- adjustable sample speed: 4...12KHz
- memory write up to: 100.000 recordings
- operating temp. range: 0..50°C / 32...122°F
- dimensions: 110x75x25mm / 4.33 x 2.95 x 0.98"

# Leds and how to use them

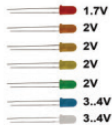

Leds feature a specific voltage drop, depending on type and colour. Check the datasheet for exact voltage drop and rated current !

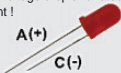

Never connect leds in parallel

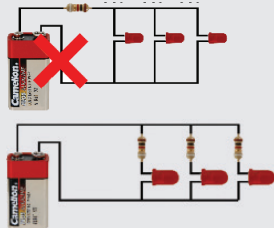

How to Calculate the series resistor:

Example: operate a red led (1.7V) on a 9Vdc source.

Required led current for full brightness: 5mA (this can be found in the datasheet of the led)

$$\frac{\text{Supply voltage (V) - led voltage (V)}}{\text{required current (A)}} = \text{series resistance (ohms)}$$



$$\frac{9V - 1.7V}{0.005A} = 1460 \text{ ohm}$$

closest value :  
use a 1k5 resistor

Required resistor power handling=  
voltage over resistor x current passed trough resistor



$$(9V - 1.7V) \times 0.005A = 0.036W$$

a standard 1/4W resistor  
will do the job

LEDs in series:

Example: 3 x red led (1.7V) on 9V battery

Required led current for full brightness: 5mA  
(this can be found in the datasheet of the led)

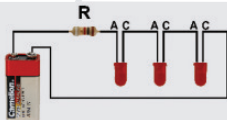

$$\frac{\text{Supply voltage (V) - (number of leds x led voltage (V))}}{\text{required current (A)}} = \text{series resistance (ohms)}$$



$$\frac{9V - (3 \times 1.7V)}{0.005A} = 780 \text{ ohm}$$

use an  
820 ohm resistor

## open collector outputs

An open collector output can be compared to a switch which switches to ground when operated

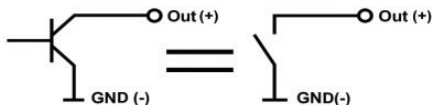

Example: How to switch an LED by means of an open collector output

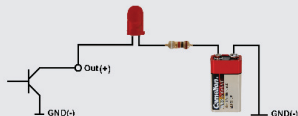

## assembly hints

### 1. Assembly (Skipping this can lead to troubles !)

Ok, so we have your attention. These hints will help you to make this project successful. Read them carefully.



#### 1.1 Make sure you have the right tools:

- A good quality soldering iron (25-40W) with a small tip.
- Wipe it often on a wet sponge or cloth, to keep it clean; then apply solder to the tip, to give it a wet look. This is called 'thinning' and will protect the tip, and enables you to make good connections. When solder rolls off the tip, it needs cleaning.
- Thin raisin-core solder. Do not use any flux or grease.
- A diagonal cutter to trim excess wires. To avoid injury when cutting excess leads, hold the lead so they cannot fly towards the eyes.
- Needle nose pliers, for bending leads, or to hold components in place.
- Small blade and Phillips screwdrivers. A basic range is fine.

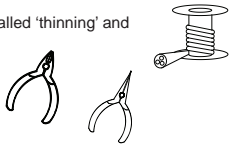

For some projects, a basic multi-meter is required, or might be handy



#### 1.2 Assembly Hints :

- Make sure the skill level matches your experience, to avoid disappointments.
- Follow the instructions carefully. Read and understand the entire step before you perform each operation.
- Perform the assembly in the correct order as stated in this manual
- Position all parts on the PCB (Printed Circuit Board) as shown on the drawings.
- Values on the circuit diagram are subject to changes, the values in this assembly guide are correct\*
- Use the check-boxes to mark your progress.
- Please read the included information on safety and customer service

\* Typographical inaccuracies excluded. Always look for possible last minute manual updates, indicated as 'NOTE' on a separate leaflet.

#### 1.3 Soldering Hints :

1. Mount the component against the PCB surface and carefully solder the leads
2. Make sure the solder joints are cone-shaped and shiny
3. Trim excess leads as close as possible to the solder joint



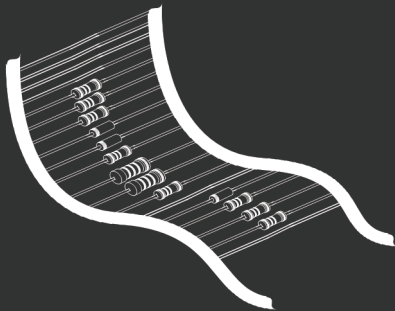

REMOVE THEM FROM THE TAPE ONE AT A TIME !

Included in  
this kit



## 2. RESISTOR

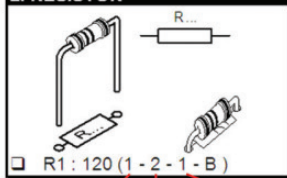

COLOUR	COLOUR NAME	1ST DIGIT/ STRIPE	2ND DIGIT/ STRIPE	3RD DIGIT/ STRIPE	MULTIPLIER STRIPE	TOLE 4TH!
Black	BLACK	0	0	0	x1	1%
Brown	BROWN	1	1	1	x10	
Red	RED	2	2	2	x100	
Orange	ORANGE	3	3	3	x1.000	
Yellow	YELLOW	4	4	4	x10.000	
Green	GREEN	5	5	5	x100.000	
Blue	BLUE	6	6	6	x1.000.000	

DO NOT BLINDLY FOLLOW THE ORDER OF THE COMPONENTS ONTO THE TAPE. ALWAYS CHECK THEIR VALUE ON THE PARTS LIST!

## 1 Resistors

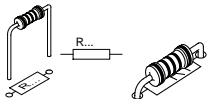

- R1 ... R3 : 4K7 (4-7-2-B)
- R4, R5 : 1K (1-0-2-B)
- R6 : 100K (1-0-4-B)
- R7 : 47K (4-7-3-B)
- R8 : 390 (3-9-1-B)
- R9 : 10 (1-0-0-B)
- R10 : 10K (1-0-3-B)

## 2 Ceramic Capacitor



- C1 ... C9 : 100nF

## 3 Diode (Check polarity!)

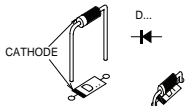

- D1: 1N4007

## 4 IC-socket

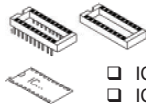

- IC1 : 28p
- IC2 : 8p

## 5 Ceramic Capacitor



- C10 : 47nF

## 6 Trimmer

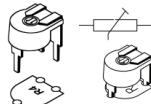

- RV1 : 100K (Sample Freq.)
- RV2 : 10K (volume)

## 7 Push buttons

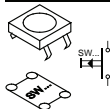

- SW1 : record
- SW2 : play
- SW3 : erase
- SW4 : next

## 8 Voltage regulator

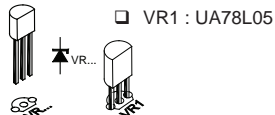

- VR1 : UA78L05

## 9 Pin-header

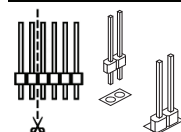

- JP1 : 2pins

## 10 Microphone



Watch the polarity!

- MIC1 : M300

## 11 DC-jack



- SK1 : 9 ... 12VDC

## 12 Board-to-wire connector

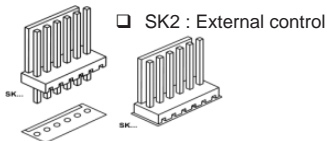

## 13 LEDs

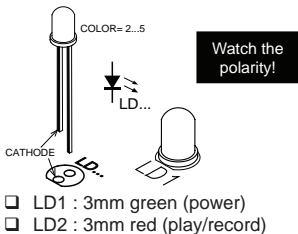

## 14 Electrolytic capacitors

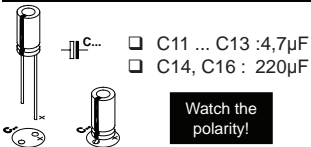

## 15 Terminal block



## 16 Vertical cinch connector

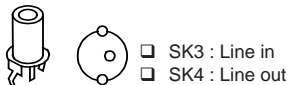

## 17 IC's

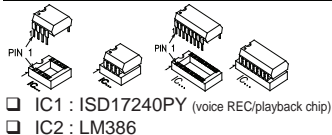

## Sampling Frequency



Turn RV1 left to decrease the sample rate and increase the total recording time, turn it fully clockwise to decrease the total recording time. The shorter the recording time the higher the quality of the played message.

Basic connection diagram

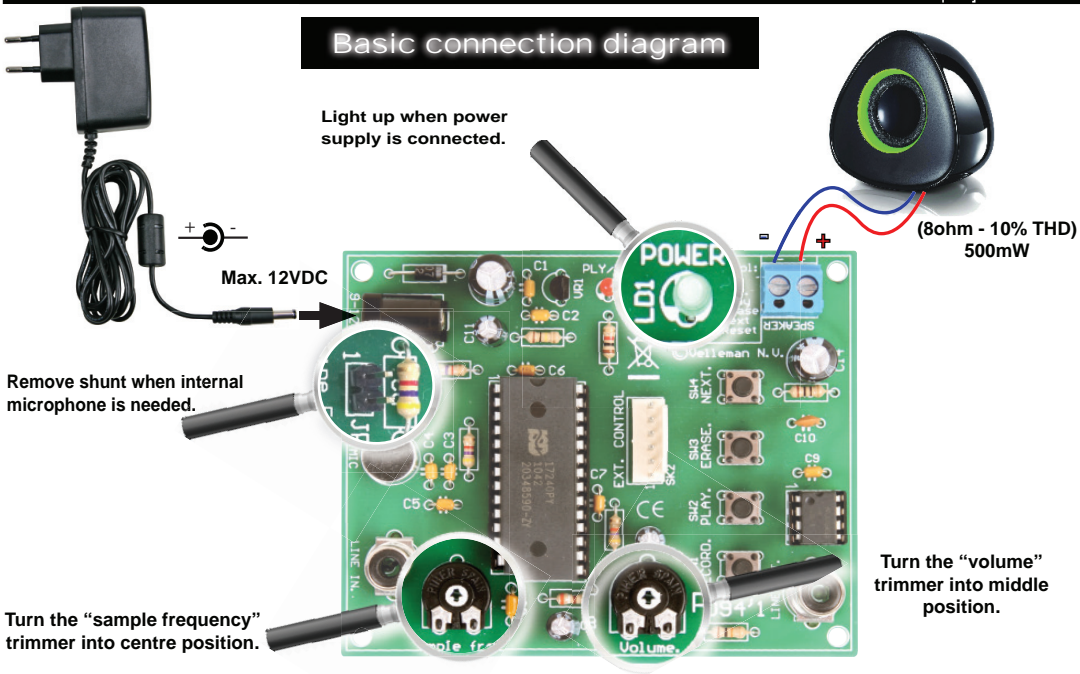



**Record a message:**

1. Keep button [SW1](#) pressed to record.
2. Release button [SW1](#) to end recording.

☞ Repeat this procedure to record a next message.

**Play latest recorded message:**

Briefly press button [SW2](#) to play the latest recorded message.

**Play all messages:**

Keep button [SW2](#) pressed to play all message, releasing the button will end the play-function.

**Play next message:**

Each time you press the button [SW4](#) you move the memory pointer 1 recorded message further

**Erase latest message:**

Briefly press button [SW3](#) to erase latest recorded message. Led LD2 will flash 2x to confirm.

**Erase all messages:**

Keep button [SW3](#) pressed to erase all recorded messages. Led LD2 will flash 9x to confirm.

**Extended possibilities**

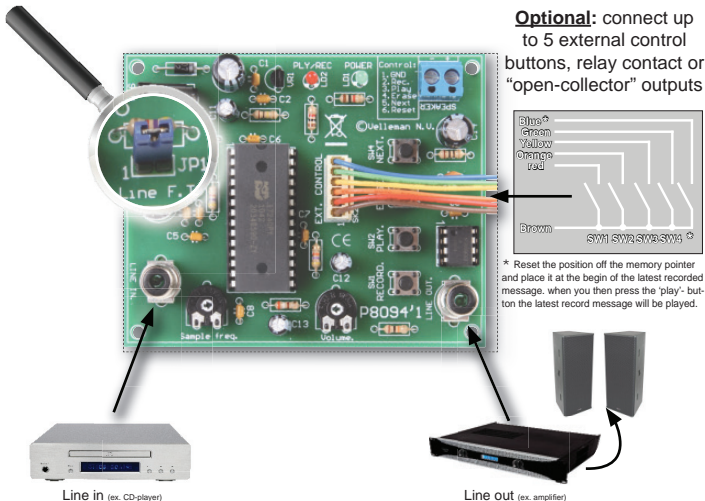

**Optional:** connect up to 5 external control buttons, relay contact or "open-collector" outputs

\* Reset the position of the memory pointer and place it at the begin of the latest recorded message. when you then press the 'play'-button the latest record message will be played.

When you use a "line in" input mount a jumper on JP1 to disable the internal microphone.

Use the "Line out" output if the internal amplifier is not sufficient enough.

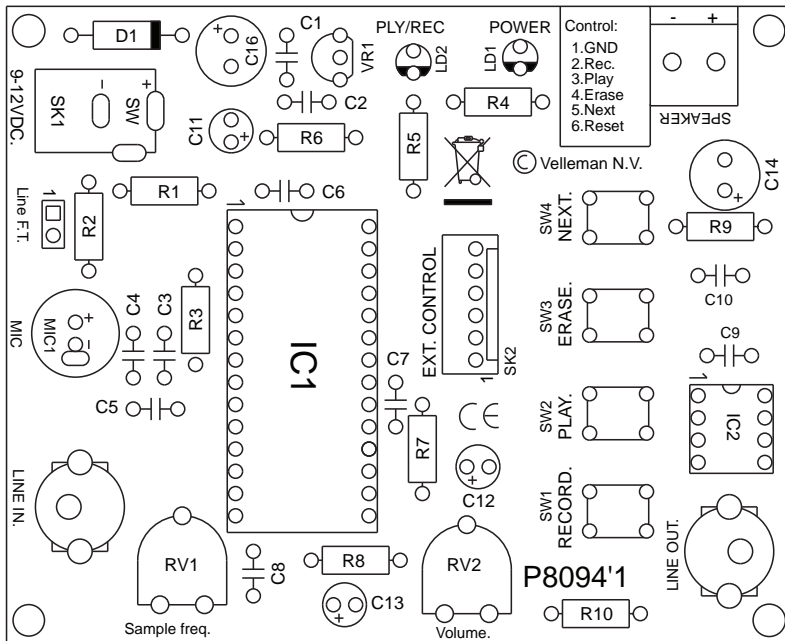





The new Velleman Projects catalogue is  
now available. Download your copy here:  
[www.vellemanprojects.eu](http://www.vellemanprojects.eu)



Modifications and typographical errors reserved - © Velleman nv. H8094'IP  
Velleman NV, Legen Heirweg 33 - 9890 Gavere.